

RS-485 Quick Start Guide

EC042B IDEA™ Motor Series



Components	
Name	Part Number
I/O Cable*	56-1352
Power Cable*	56-1348
USB Cable*	56-1346
RS485 Cable*	56-1536-1
USB to RS485 Converter *	UTR4852
Motor/Drive	EC042B-xOMP-91x

*Cables and converter not included with Motor/Drive and must be purchased separately.

Install the Software on your Windows-Based PC

1. From our website, download the EC042B IDEA Motor software to your desktop. [Download software.](#)

 IDEADrive Software Setup compressed (zipped) folder.

2. Right click on the folder to extract files.

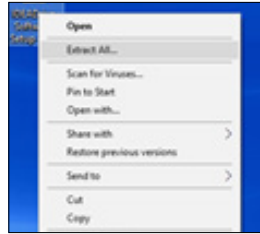

3. Double click on the "IDEADrive Software Setup" to begin the installation.



4. Click "Next."



5. Select "I accept the terms in the license agreement" and click "Next"



6. Click "Install"

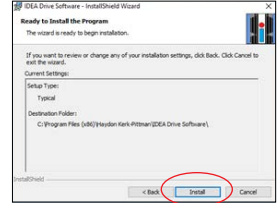

7. Click "Finish"



8. Double click the IDEA Drive icon.



If an FTDI driver has not been installed or if it needs an update, the following windows will appear.

1. Click "Yes" when it asks to update.

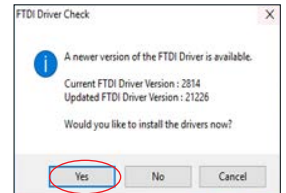

2. Click "Extract"



3. Click "Next"

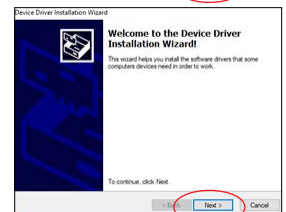

4. Accept agreement and click "Next"

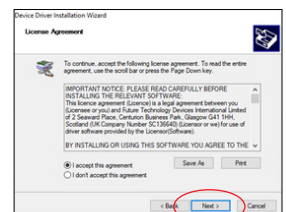

5. Once installation completes, click "Finish"

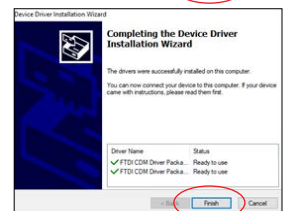

Operating Motor/Drive

1. Plug USB Cable 56-1346 to computer and UTR4852 converter. Plug RS-485 Cable 56-1536-1 to converter and Motor. Plug Power Cable 56-1348 into the motor and connect to a power supply.”

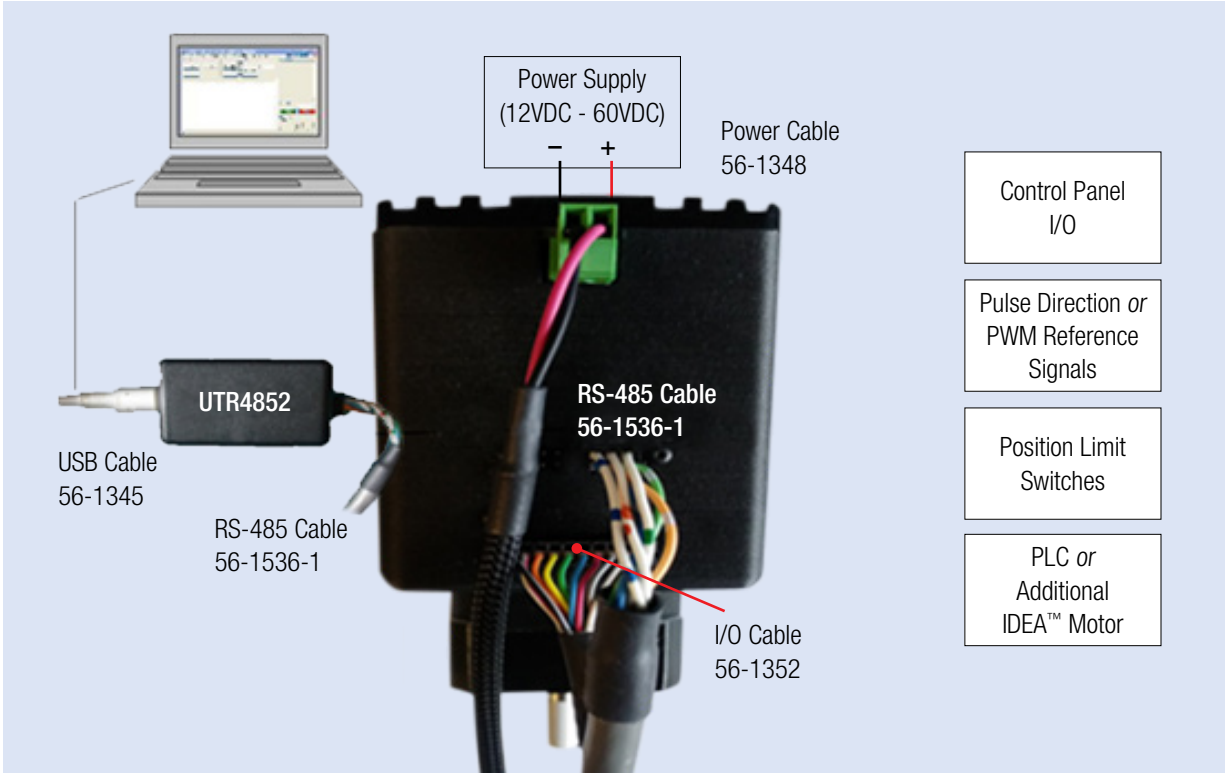

2. Plug the USB Cables in PC and Ensure Drive is recognized by the computer prior to running software, otherwise the GUI will open in offline mode. Turn on the power supply. Launch IDEA Drive GUI by double clicking on IDEA Drive icon.



3. Select Brushless.



4. Give it a configuration name.
5. Select a motion command and fill out the information. Highlighted in orange.

